

16mm metal push button switch

Part Number

16													-	□	□	□	□	□	□	□	□	□	□
Company code	Mounting Hole Size	Series	Actuator type	Contact Combination	Operation type	Connection type	LED type	LED color	LED Voltage	Button color	Housing color	Shell Material											
WD	Φ16mm	A	F Flat	10 1NO	M Momentary	Q Solder Terminal (Quick-connect)	N No LED	N No LED	N No LED	N Natural	N Natural	S Stainless Steel											
		B	H High flush (Raised)	11 1NO1NC 22 2NO2NC	L Self-locking (Latched)	S Screw Terminal	D Dot	R Red	1 2V 2 3V	R Red	R Red	B Brass Nickel											
		C	B (Ball Dome)				R Ring	O Orange	3 6V	O Orange	O Orange	A Zn-Al Alloy Anodized											
		D	K Knob				M Dot and Ring	Y Yellow	4 12V	Y Yellow	Y Yellow	P PBT											
			L Key lock				S Symbol (Power Symbol Other Symbol)	G Green	5 24V	G Green	G Green	G Gold-plated											
						X Ring and Symbol	B Blue	6 36V	B Blue	B Blue													
								7 48V	W White	W White	W White												
								8 110V	D Bicolor	L Black	L Black												
								9 220V	T Tricolor														
									Note: Can be customized.	Note: Can be customized.													

Remark: Please choose the suitable code according to the information above.

Switch Structure

Type	Symbol	Diagram	Explanation
NO.1			Switch with two terminal breakpoints slow moving contact Individual products can be customized normally closed switch, refer to product description.
NO.2			

LED Specification

Lamp Type	LED (AC/DC)	<p>LED can be used in AC and DC, with a resistor for different voltage protection.</p>
Rated Voltage	2V/3V/6V/12V/24V/36V/48V/110V/220V or customized	
Rated Current	About 15mA	
Color	R O Y G B W or customized.	
Life	40000 Hours	

Remark: LED can be customized to meet special requirement.

Panel Installation

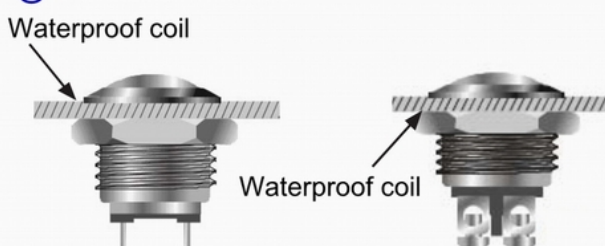

Related Certification



16-A-F10-MQ-D-O-5-N-N-S



Mounting Hole Size: ϕ 16mm
 Switch Rating: 2A/36VDC
 Contact Combination: 1NO
 Operation type: Off-Momentary (On)
 Actuator type: Flat
 LED type: Dot
 Shell Material: Brass nickered/Stainless steel
 Protection Level: IP65

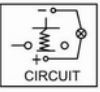
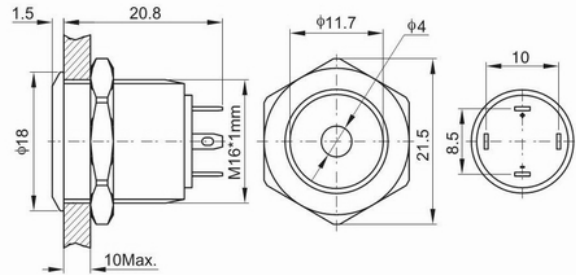

16-A-F10-MQ-R-O-5-N-N-S



Mounting Hole Size: ϕ 16mm
 Switch Rating: 2A/36VDC
 Contact Combination: 1NO
 Operation type: Off-Momentary (On)
 Actuator type: Flat
 LED type: Ring
 Shell Material: Brass nickered/Stainless steel
 Protection Level: IP65

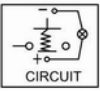
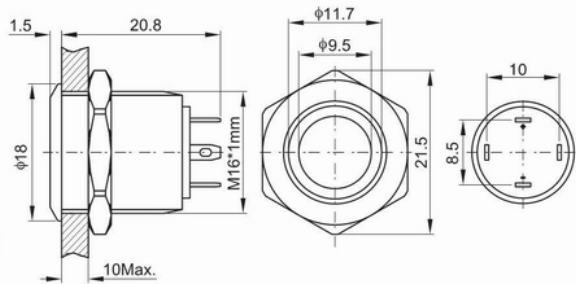

16-A-F10-MQ-M-O-5-N-N-S



Mounting Hole Size: ϕ 16mm
 Switch Rating: 2A/36VDC
 Contact Combination: 1NO
 Operation type: Off-Momentary (On)
 Actuator type: Flat
 LED type: Dot and Ring
 Shell Material: Brass nickered/Stainless steel
 Protection Level: IP65

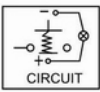
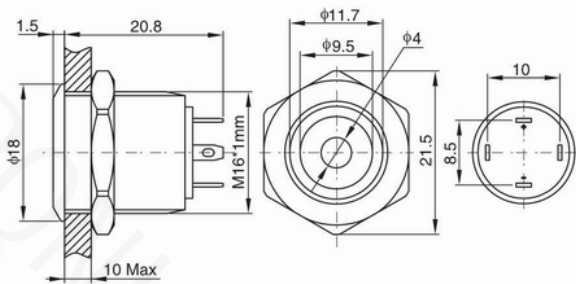

Product Standards		16-A-F10-MQ-D-O-5-N-N-S	16-A-F10-MQ-R-O-5-N-N-S	16-A-F10-MQ-M-O-5-N-N-S
Terminal Type		Solder Terminal (1.8 x 0.5)	Solder Terminal (1.8 x 0.5)	Solder Terminal (1.8 x 0.5)
Contact combination		1NO	1NO	1NO
Rating		2A/36VDC	2A/36VDC	2A/36VDC
Contact Resistance		$\leq 50m\Omega$	$\leq 50m\Omega$	$\leq 50m\Omega$
Insulation Resistance		$\geq 1000M\Omega$	$\geq 1000M\Omega$	$\geq 1000M\Omega$
Dielectric Strength		2000VAC	2000VAC	2000VAC
Environment Temperature		-20°C~+55°C	-20°C~+55°C	-20°C~+55°C
Mechanical Life		>1,000,000 times	>1,000,000 times	>1,000,000 times
Electrical Life		>200,000 times	>200,000 times	>200,000 times
Panel Thickness		1~10mm	1~10mm	1~10mm
Nut Torque		5~14Nm	5~14Nm	5~14Nm
Operating Pressure		About 4N	About 4N	About 4N
Operating Stroke		About 2.0mm	About 2.0mm	About 2.0mm
Protection Lever		IP65	IP65	IP65
Material	Contact	Silver alloy	Silver alloy	Silver alloy
	Button	Brass nickered Stainless steel	Brass nickered Stainless steel	Brass nickered Stainless steel
	Body	Brass nickered Stainless steel	Brass nickered Stainless steel	Brass nickered Stainless steel
	Base	PBT	PBT	PBT
Lamp parameters	Types	Dot	Ring	Dot and Ring
	Rated Voltage	2V/3V/6V/12V/24V/36V/48V/110V/220V or customized.		
	Color	R O Y G B W or customized. R O Y G B W or customized. R O Y G B W or customized.		
	Life	40000 Hours	40000 Hours	40000 Hours

16-A-H10-MQ-D-O-5-N-N-S



Mounting Hole Size: Φ 16mm
 Switch Rating: 2A/36VDC
 Contact Combination: 1NO
 Operation type: Off-Momentary (On)
 Actuator type: High flush(Raised)
 LED type: Dot
 Shell Material: Brass nickeled/Stainless steel
 Protection Lever: IP65

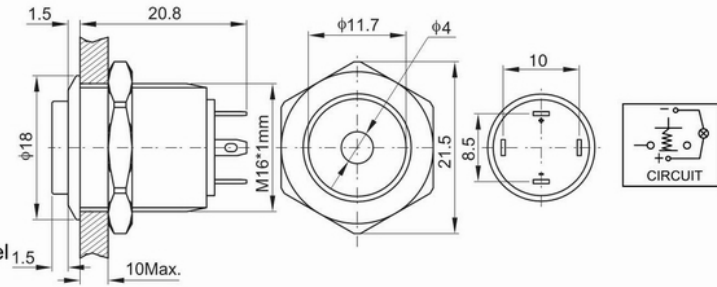

16-A-H10-MQ-R-O-5-N-N-S



Mounting Hole Size: Φ 16mm
 Switch Rating: 2A/36VDC
 Contact Combination: 1NO
 Operation type: Off-Momentary (On)
 Actuator type: High flush(Raised)
 LED type: Ring
 Shell Material: Brass nickeled/Stainless steel
 Protection Lever: IP65

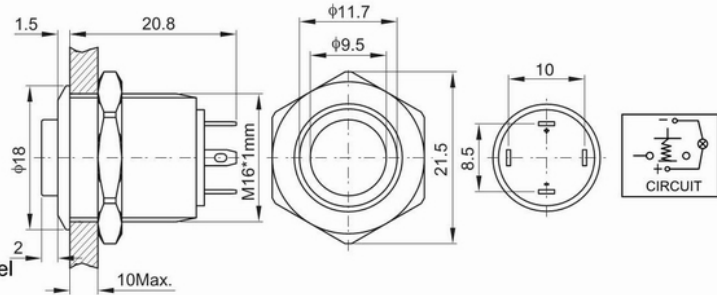

16-A-H10-MQ-M-O-5-N-N-S





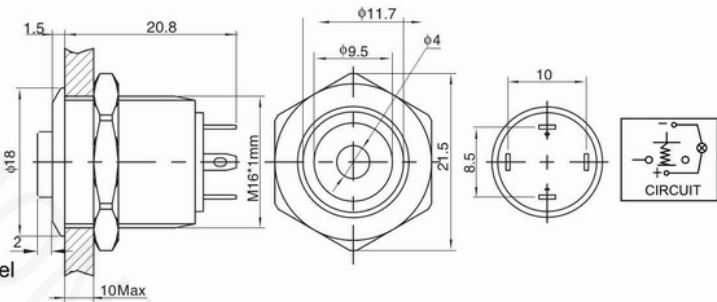

Mounting Hole Size: Φ 16mm
 Switch Rating: 2A/36VDC
 Contact Combination: 1NO
 Operation type: Off-Momentary (On)
 Actuator type: High flush(Raised)
 LED type: Dot and Ring
 Shell Material: Brass nickeled/Stainless steel
 Protection Lever: IP65

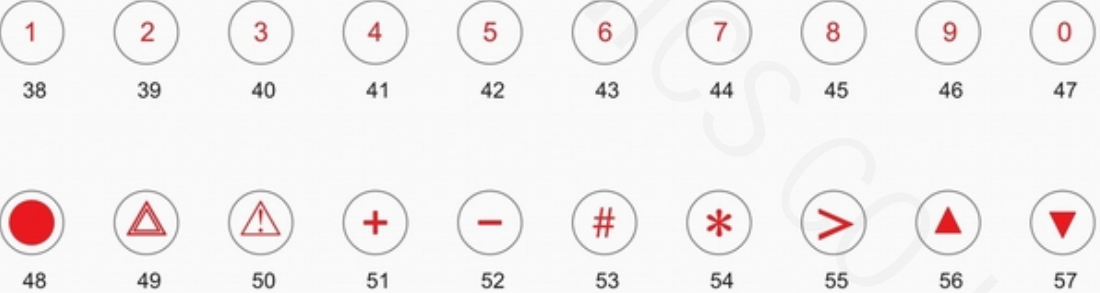

Product Standards		16-A-H10-MQ-D-O-5-N-N-S	16-A-H10-MQ-R-O-5-N-N-S	16-A-H10-MQ-M-O-5-N-N-S
Terminal Type		Solder Terminal (1.8 x 0.5)	Solder Terminal (1.8 x 0.5)	Solder Terminal (1.8 x 0.5)
Contact combination		1NO	1NO	1NO
Rating		2A/36VDC	2A/36VDC	2A/36VDC
Contact Resistance		$\leq 50m\Omega$	$\leq 50m\Omega$	$\leq 50m\Omega$
Insulation Resistance		$\geq 1000M\Omega$	$\geq 1000M\Omega$	$\geq 1000M\Omega$
Dielectric Strength		2000VAC	2000VAC	2000VAC
Environment Temperature		-20°C~+55°C	-20°C~+55°C	-20°C~+55°C
Mechanical Life		>1,000,000 times	>1,000,000 times	>1,000,000 times
Electrical Life		>200,000 times	>200,000 times	>200,000 times
Panel Thickness		1~10mm	1~10mm	1~10mm
Nut Torque		5~14Nm	5~14Nm	5~14Nm
Operating Pressure		About 4N	About 4N	About 4N
Operating Stroke		About 2.0mm	About 2.0mm	About 2.0mm
Protection Lever		IP65	IP65	IP65
Material	Contact	Silver alloy	Silver alloy	Silver alloy
	Button	Brass nickeled Stainless steel	Brass nickeled Stainless steel	Brass nickeled Stainless steel
	Body	Brass nickeled Stainless steel	Brass nickeled Stainless steel	Brass nickeled Stainless steel
	Base	PBT	PBT	PBT
Lamp parameters	Types	Dot	Ring	Dot and Ring
	Rated Voltage	2V/3V/6V/12V/24V/36V/48V/110V/220V or customized.		
	Color	R O Y G B W or customized. R O Y G B W or customized. R O Y G B W or customized.		
	Life	40000 Hours	40000 Hours	40000 Hours

Symbol List

Special symbols	 <p>1 2 3 4 5 6 7</p>
Letter symbol	 <p>8 9 10 11 12 13 14 15 16 17</p> <p>18 19 20 21 22 23 24 25 26 27</p> <p>28 29 30 31 32 33 34 35 36 37</p>
Numbers and symbols	 <p>38 39 40 41 42 43 44 45 46 47</p> <p>48 49 50 51 52 53 54 55 56 57</p>
Other symbols	 <p>58 59 60 61 62 63 64 65 66 67</p>

Noted: The Symbols above need to be customized.