



External material



Product overview

- Brass alloy with Electroplated and Nickel plated,corrosion resisting,vibration resisting,impact resisting.
- Bright LED lighting,basic color(Red,Green,Yellow,Blue,White),other color can be customized.
- Waterproof,grease proofing,dustproof,IP67.
- Small size,delicate appearance,economic and applicative,and high quality and value.
- Φ6mm-Φ16mm,rating with 2-220VAC/DC,which is widely used for Electronics and Electrical appliances and equipments.
- With dual color type,Red-Green with common(-) is the normal type,other colors can be customized or with common(+).



Technical parameters

Rated Current	20mA	Humidity	85% Rh and below
Rated voltage	2 ~ 220VAC/DC	Withstand Voltage	≥ 1000V 50/60Hz Last for 1min
Insulation resistance	100MΩ (Min)	Vibration	10 ~ 55Hz 1.5mm Double Amplitude
Dielectric strength	1,000V RMS (Min)	Mounting Method	Bushing mount
Base material	DuPont Nylon	Dimensions	Diameter Φ6mm, Φ8mm, Φ12mm Φ16mm



Model and meaning

8	□	□	□	□	□	□
800 waterproof Indicator	Dimension	Top form	Base form	LED Color	Voltage	Housing color
	06: Φ6mm 08: Φ8mm 12: Φ12mm 16: Φ16mm	0: Flat (1.5mm) 1: Small Flat 2: Middle head 3: High head	6: 6# Base 7: 7# Base 8: 8# Base 9: 9# Base	1: Red (R) 2: Green (G) 3: Yellow (Y) 4: Blue (BL) 5: White (W)	0: Customized 1: 2.4V 2: 6V 3: 12V 4: 24V 5: 110V 6: 220V	1: White (W) 2: Black (B)



800 Series LED Indicator Light

808 Series - $\Phi 8\text{mm}$



Dimensions

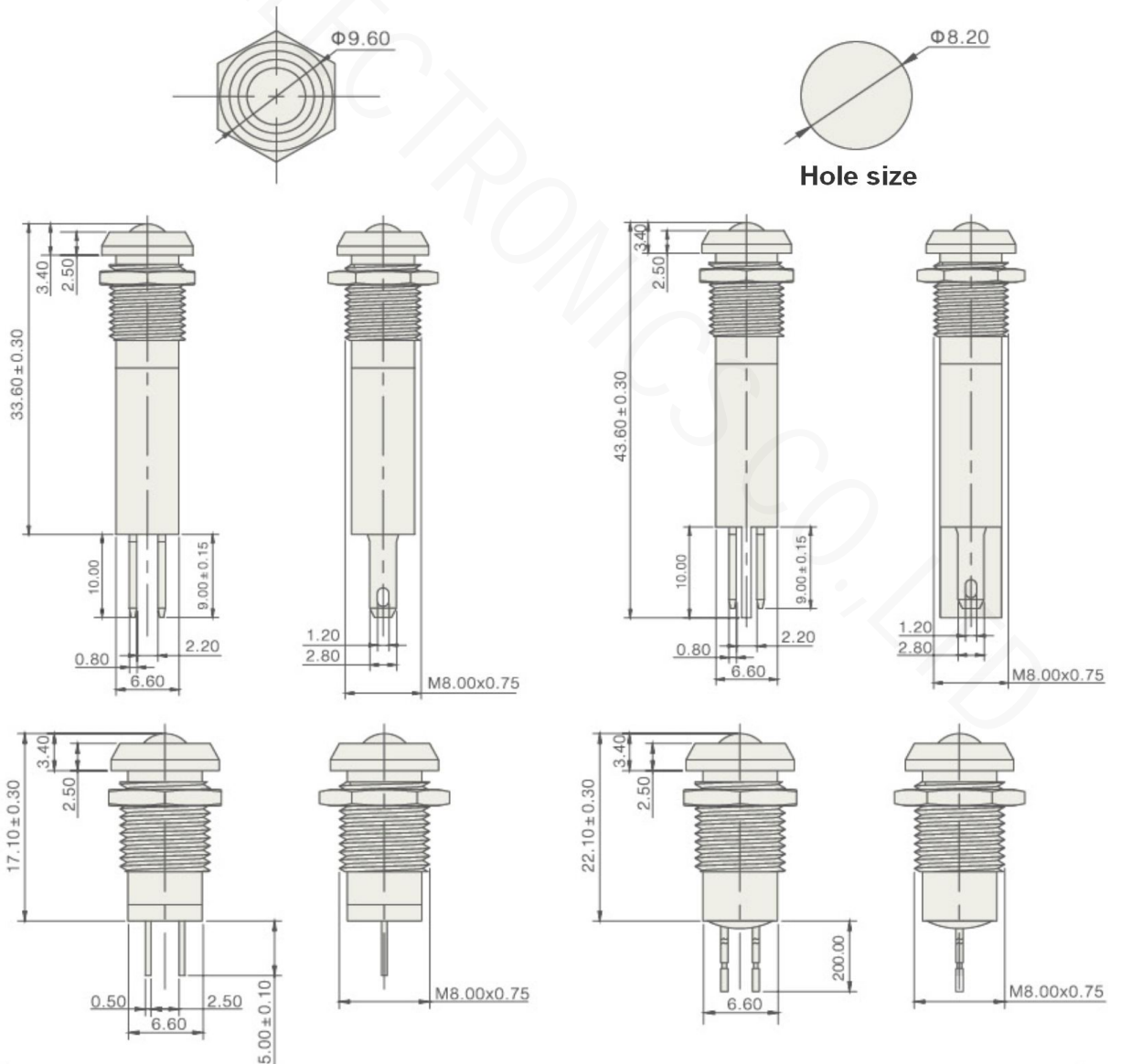

Top form

0: Flat Head

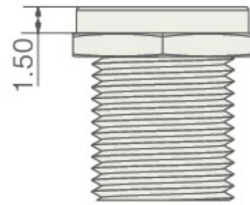

1: Small Flat Head

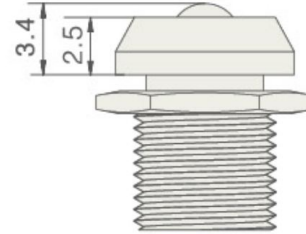

2: Middle Head

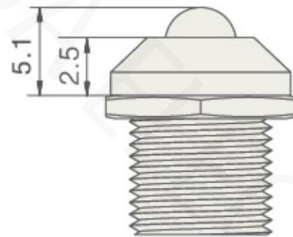

3: High Head

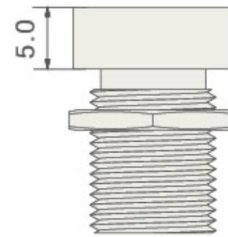

Actual size can be customized as required

Base form

6# Base

Suitable for 2~220V

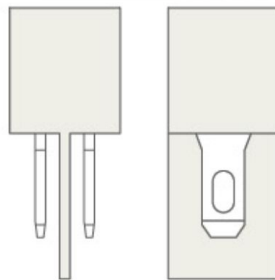

7# Base

Suitable for 2~220V

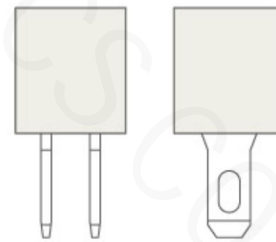

8# Base

Suitable for 2.4V

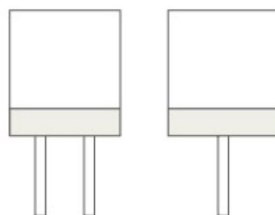

9# Base

Suitable for 2~220V

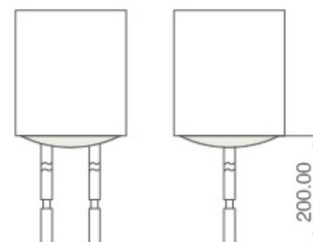

Cable's length can be customized

